

# RIK-5A Flexible Current Transformer Users Manual

Copyright © 2024 V1.1.3

This manual may not be altered or reproduced in whole or in part by any means without the expressed written consent of Accuenergy.

The information contained in this document is believed to be accurate at the time of publication, however, Accuenergy assumes no responsibility for any errors which may appear here and reserves the right to make changes without notice. Please ask the local representative for latest product specifications before ordering.

## SAFETY INFORMATION

Please read this manual carefully before installation, operation and maintenance of the Rogowski Coil Integrator Kit

The following symbols in this manual are used to provide warning of danger or risk during the installation and operation of the unit.



Electric Shock Symbol: Carries information about procedures which must be followed to reduce the risk of electric shock and danger to personal health.



Safety Alert Symbol: Carries information about circumstances which if not considered may result in injury or death.



This mark indicates that this product is UL listed.

Installation and maintenance of the Rogowski Coil Integrator Kit should only be performed by qualified, competent professionals who have received training and should have experience with high voltage and current devices.

Accuenergy shall not be responsible or liable for any damages caused by improper meter installation and/or operation.

	Product is protected by reinforced insulation
	Application Around and removal from UNINSULATED HAZARDOUS LIVE conductors is permitted

**WARNING:** Disconnect power supply before making electrical connections.

**WARNING:** Current Transformers (CT's) should be installed by trained electrician or technician.

**WARNING:** The secondary circuit of a CT should not be opened when current is flowing through the primary circuit.

# Table of Contents

---

<b>Chapter 1</b> .....	<b>4</b>
1.1 Overview .....	4
1.2 What's included.....	4
<b>Chapter 2</b> .....	<b>7</b>
2.1 Hardware Overview .....	7
2.1.1 Dimensions.....	8
2.2 Installation .....	9
2.3 Configuration.....	11
2.4 Measurements .....	12
<b>Appendix</b> .....	<b>13</b>
Technical Aspects .....	13

# **RIK-5A** Flexible Current Transformer

## **Chapter 1**

---

### **1.1 Overview**

### **1.2 What's Included**



# Chapter 1

## 1.1 Overview

The Rogowski Integrator Kit (RIK) is designed to provide users with an easy to install, plug and play, retrofit solution that can be used with any power meter or equipment with a 5A current input from a Current Transformer(CT). The flexibility of the Rogowski Coil CT's reduces the complexity and allows it use to be used for a variety of applications and configurations where special constraints may limit the use of other CT solutions. The RIK is a configurable unit that can measure current from 2.5-50000A making it ideal for any system that operates at both 50Hz and 60Hz further adding to its flexibility.

## 1.2 What's Included

The Rogowski Coil Kit includes the three phase integrator unit which contains the seven configurable CT ratios for each channel, three Rogowski coils that will measure the current (available in an array of sizes from 16" to 47") and the 24Vdc power supply to power the integrator. The integrator unit can be surfaced mounted or mounted on a standard DIN rail.

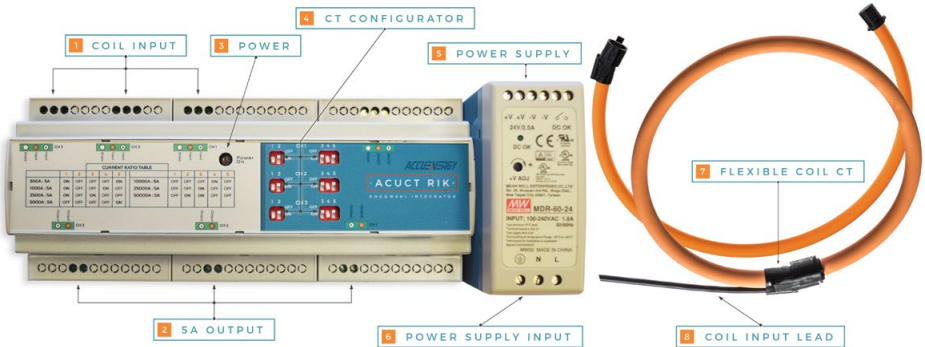

### Details:

1

#### Rogowski Coil Input

Three Channels for flexible rope style CT input.

2

#### 5A Output

Three Channels, 5A Output.

3

#### Power On Light

Indicates that the RIK is powered up.

4

#### CT Configurator

Seven individual field configurable CT ratios for each channel.

5

#### Power Supply

RIK integrated power supply.

6

#### Power Supply Input

Power supply input (100-240Vac).

7

#### Flexible Rogowski Coil Current Transformer

CT sizes available from 16-47 inches.

8

#### Coil Input Lead

Input lead for connection with RIK integrator.

# **RIK-5A** Flexible Current Tranformer

## Chapter 2

---

**2.1 Hardware Overview**

**2.2 Installation**

**2.3 Configuration**

**2.4 Measurements**

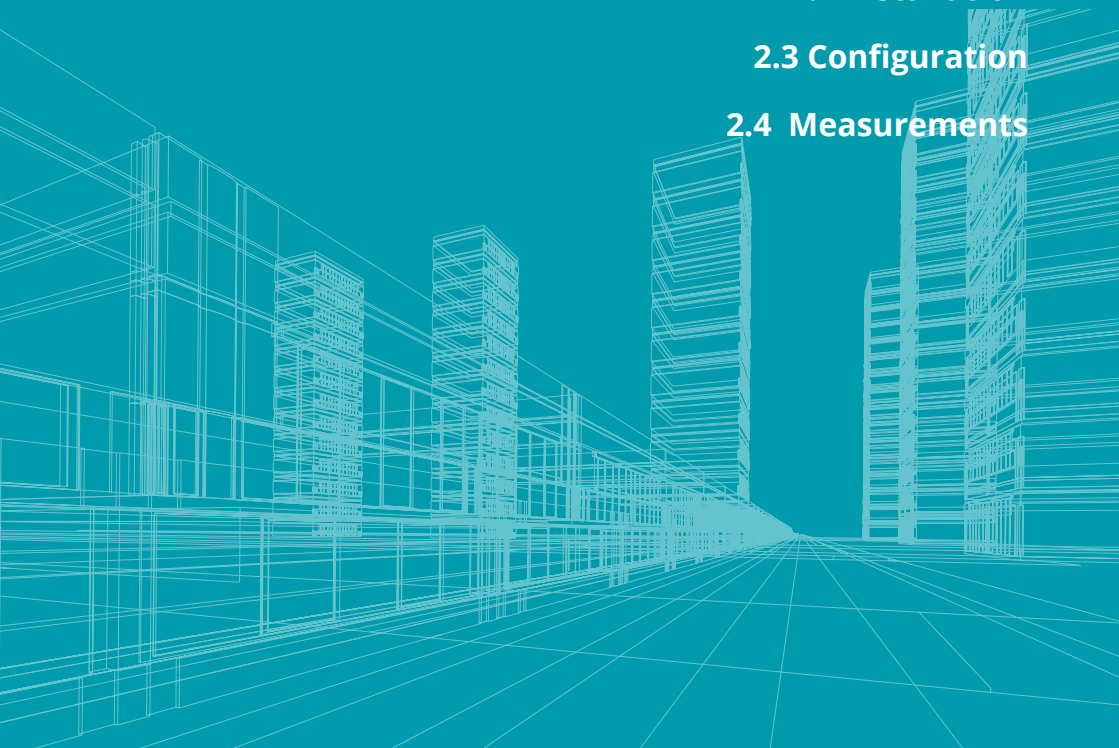



## Chapter 2

The installation method is introduced in this chapter. Please read this chapter carefully before beginning installation.

### 2.1 Hardware Overview

The RIK is composed of the integrator and power supply mounted on a DIN rail along with three Rogowski coils.

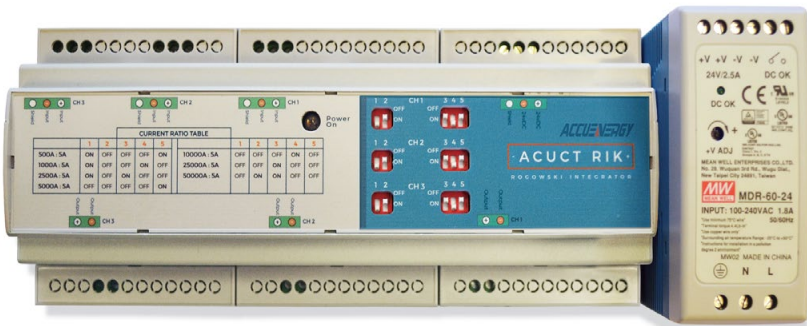

**Dimensions:**

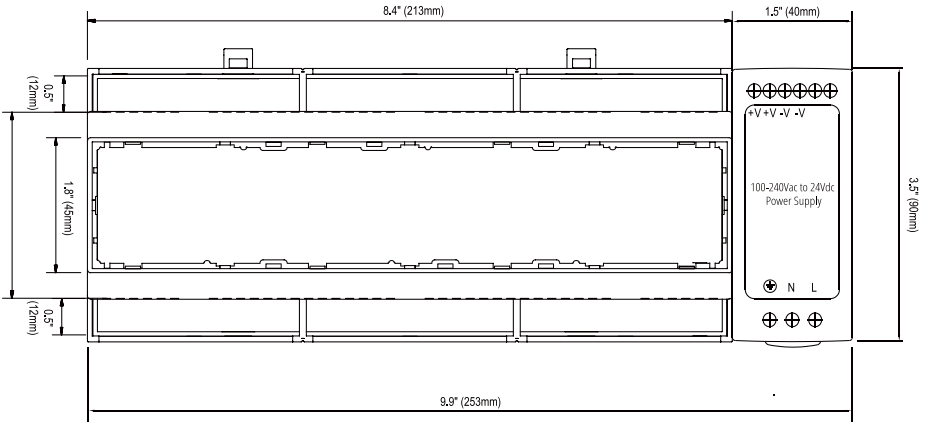

Figure 1 - Top View

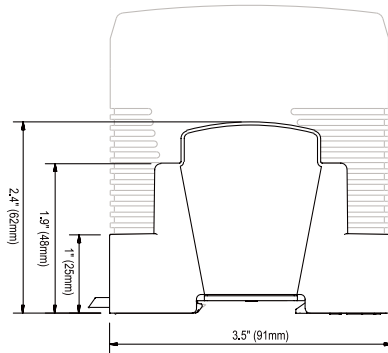

Figure 2 - Side View

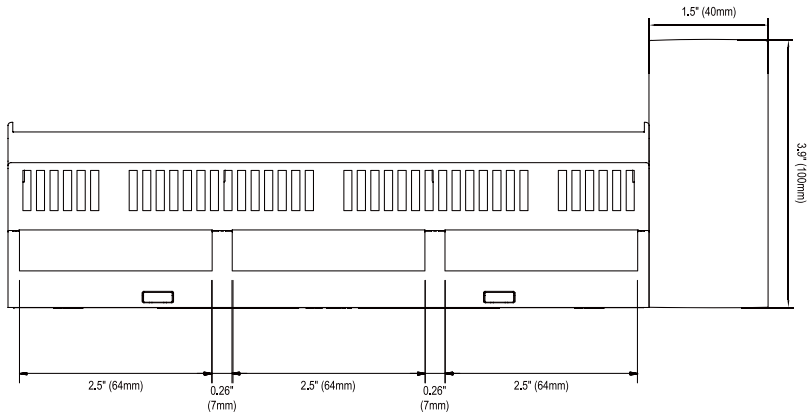

Figure 3 - Front view

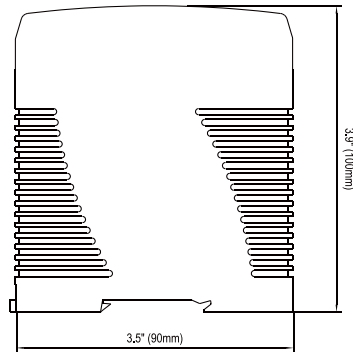
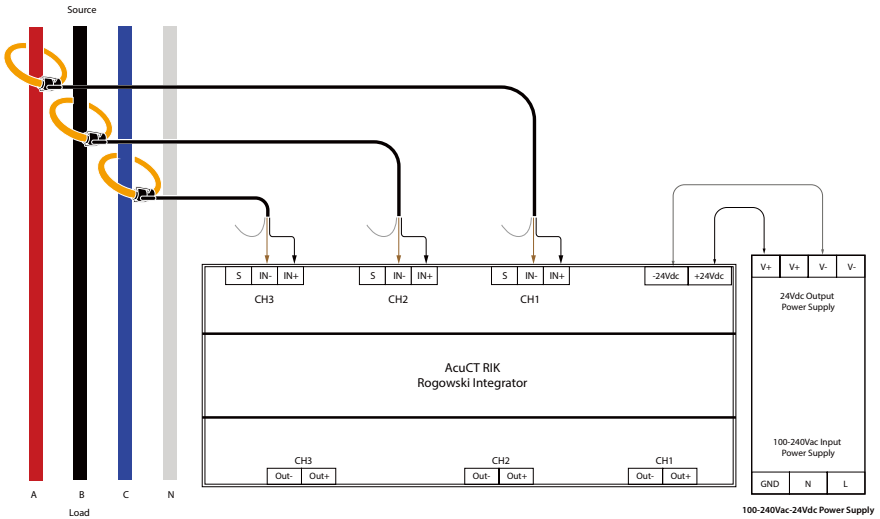

Figure 4 - Side view of Power Supply unit

## 2.2 Installation

The installation of the RIK integrator requires the user to simply connect the Rogowski coil CT's that are provided with the kit to the integrator and wire the 5A output to the power meter or equipment which will take the signal. If the system is single phase or there are two phases only the phases that need CT's will need to be connected to the input of the integrator.

The diagram below illustrates how to connect the integrator.



**Input:**

The provided Rogowski coils are the input to the integrator. Connect the Rogowski coil leads to the input channel on the integrator. The white leads of the CT are the positive wire and the brown lead is the negative wire.

- Connect the white lead to 'IN+' and the brown lead to 'IN-'. The Shield of the Rogowski coil should be left floating. Open the coil by pulling apart the black connector of the CT.
- Open the coil by pulling apart the black connector of the CT.
- Install the CT around the conductor to be measured. Verify the CT is installed with the CT facing the same direction as the current flow direction indicated by the arrow on the black connector.
- Re-attach the coil together.
- Repeat above steps if using more than one CT.

Ensure that the CT connected to each channel of the integrator is around the correct phase/line voltage.

**Output:**

Connect each output channel to the meter or equipment with 5A input.

- 'OUT+' is to be connected to the positive current output terminal of meter.
- 'OUT-' is to be connected to the negative current output terminal of meter.

### Power Supply:

The RIK requires 24Vdc power to operate. There is a 100-240Vac (50/60Hz) adapter that is mounted beside the meter and pre-wired to the integrators power supply terminals to provide this power.

- Connect the input power supply that is between 100-240Vac to the 'L' and 'N' terminals of the power supply.

## 2.3 Configuration

The face of the integrator has 3 sets of dip switches that are used to configure the current range that the corresponding channels that will be used to measure.

When the dip switch is in the up position the dip switch is considered to be Off. When the dip switch is in the down position the dip switch is considered as On.

Configure each channels dip switches to output the desired range. For example to measure current rated for 1000A the dip switches 1 through 5 for the three channels must be configured to be 'ON', 'OFF', 'OFF', 'ON' and 'OFF' respectively.

- Enter this current ratio into the meter or equipment so it can read accurately from the integrator.

### Current Ratio Table

	1	2	3	4	5
500:5A	ON	OFF	OFF	OFF	ON
1000:5A	ON	OFF	OFF	ON	OFF
2500:5A	ON	OFF	ON	OFF	OFF
5000:5A	OFF	OFF	OFF	OFF	ON
10000:5A	OFF	OFF	OFF	ON	OFF
25000:5A	OFF	OFF	ON	OFF	OFF
50000:5A	OFF	ON	ON	OFF	OFF

## 2.4 Measurements

For each current range the integrator will be able to measure the current from 0.5% up to 120% of the rated current. That is when the integrator is configured to measure a current rated for 1000A it will measure the current from 5A to 1200A. The integrator will output 5/10V at the rated current of 1000A and will output its maximum of 6/12V at 1200A.

The table below provides all the ranges of current that can be measured for each range.

### Current Range Setting

Primary Input (ARMS)	Sensing Range (A)	Output	CT Ratio
500	2.5 to 600	5A @ 500A	500:5
1000	5 to 1200	5A @ 1000A	1000:5
2500	12.5 to 3000	5A @ 2500A	2500:5
5000	25 to 6000	5A @ 5000A	5000:5
10000	50 to 12000	5A @ 10000A	10000:5
25000	125 to 30000	5A @ 25000A	25000:5
50000	250 to 60000	5A @ 50000A	50000:5

### Appendix:

#### Key Specifications

Specifications	Measurements
Current Measurement Range	2.5A - 60000A
Output Current	0-6ARMS (0-5ARMS Nominal)
Sensing Range	500A, 1000A, 2500A, 5000A, 10000A, 25000A and 50000A (user selectable)
Maximum Burden	1.8VA per channel
Maximum Output Impedence	50mΩ
Measurement Channels	3 (three-phase or single-phase)
Frequency	45Hz to 65Hz
Accuracy	- +1% Full Scale Error
Channel Cross Talk	<-60dB
Maximum Operating Temperature	55oC (131oF)



**ACCUEENERGY INC.**

440 Comstock Road  
Toronto, ON M1L 2H6, Canada

TF: 1-877-721-8908  
INT: +1-416-497-4100  
FAX: +1-416-497-4130  
E: [marketing@accuenergy.com](mailto:marketing@accuenergy.com)



Revised: September 2024