









Three Phase Panel Mount Metering Kit - Summary Sheet

Our three phase Panel Mount metering kit is built for fast and easy installation and is ideal for retrofit applications. The compact enclosure has top and bottom cable entry points and our meter engineers pre-fit the required CT links, voltage reference and earthing with clear labelling. It comes complete with split core CT's that simply clip around the supplies, saving time and disruption.

This kit is available with one of four meters offering a range of features from simple pulse outputs to remote access to readings via ethernet. You can also select CT's appropriate for your circuit with 24mm & 36mm apertures available covering loads of 100A to 400A. Can't find a meter or CT to suit your requirements, contact our friendly sales teams who will be happy to put together a bespoke quotation.

What's included?

-  1 x 3-Phase Panel Mount Meter (see options on left)
-  1 x Steel Meter Enclosure (H-300mm x W-200mm x D-130mm)
-  3 x Split Core CT (select ratio & aperture upon order)
-  CT links, voltage reference and earthing terminals
-  1m of 1.5mm stranded blue, brown, black & grey cable
-  1m of 2.5mm stranded earth cable

Product Code

MKP

Power Supply

Three Phase

Availability

Special Order *

* Our pre-wired enclosures are built to order and are typically available in 2-3 days, however in times of high demand, this lead time may increase. Please contact us for more information.

Meter Options

	ND Metering Solutions - Cube 300	Eastron - Smart X96-5E	Socomec - Diris A14	ND Metering Solutions - Cube 400IP
MID Approved	No	Yes	Yes	No
Output Type	Pulse	RS485 Modbus & Pulse	RS485 Modbus	Ethernet
Tariffs	Single	Single	Single	Single
Import / Export	Import Only	Import & Export	Import & Export	Import & Export
Part Code	MKPND3	MKPEA96	MKPSO14	MKPND4

Wiring Guide

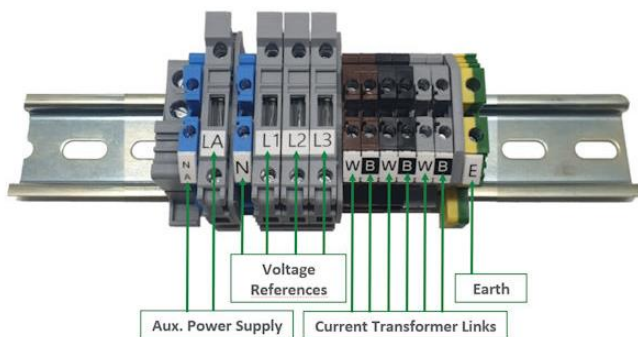

Current Transformer Options

Part Code *	Ratio	Aperture
3CT100T24	100/5	24mm
3CT100T36	100/5	36mm
3CT150T24	150/5	24mm
3CT150T36	150/5	36mm
3CT200T24	200/5	24mm
3CT200T36	200/5	36mm
3CT250T24	250/5	24mm
3CT250T36	250/5	36mm
3CT300T24	300/5	24mm
3CT300T36	300/5	36mm
3CT400T36	400/5	36mm

* Set of 3 Split Core CT's

Web: www.spwales.com | Email: sales@spwales.com | Phone: 01803 295430 | Fax: 01803 212819

While Stephen P Wales Ltd has made every reasonable effort to ensure the accuracy of this information, Stephen P Wales Ltd does not guarantee that it is error-free, nor does Stephen P Wales Ltd make any other representation, warranty or guarantee that the information is accurate, correct, reliable or current. Stephen P Wales Ltd reserves the right to make any adjustments to the information contained herein at any time without notice.