









## Three Phase Wall Mounted Metering Kit - Summary Sheet

Our three phase Wall Mounted metering kit is built for fast and easy installation and is ideal for retrofit applications. The compact enclosure has top and bottom cable entry points and our meter engineers pre-fit the required CT links, voltage reference and earthing with clear labelling. It comes complete with split core CT's that simply clip around the supplies, saving time and disruption.

This kit is available with one of three meters offering a range of features from simple pulse outputs to remote access to readings via GPRS. You can also select CT's appropriate for your circuit with 24mm & 36mm apertures available covering loads of 100A to 400A. Can't find a meter or CT to suit your requirements, contact our friendly sales teams who will be happy to put together a bespoke quotation

### What's included?

-  1 x 3-Phase Wall Mounted Meter (see options below)
-  1 x Meter Enclosure (H-300mm x W-250mm x D-150mm)
-  3 x Split Core CT (select ratio & aperture upon order)
-  CT links, voltage reference and earthing terminals
-  1m of 1.5mm stranded blue, brown, black & grey cable
-  1m of 2.5mm stranded earth cable

**Product Code**

**MKW**

**Power Supply**

**Three Phase**

**Availability**

**Special Order \***

\* Our pre-wired enclosures are built to order and are typically available in 2-3 days, however in times of high demand, this lead time may increase. Please contact us for more information.

### Meter Options

	Iskra MT174	Iskra MT382	Elster A1700
<b>MID Approved</b>	Yes	Yes	Yes
<b>Output Type</b>	Pulse	Mbus	RS485 Modbus & GSM Modem *
<b>Tariffs</b>	Multiple **	Multiple **	Multiple **
<b>Import / Export</b>	Import & Export	Import & Export	Import & Export
<b>Part Code</b>	MK174	MKW382	MKW1700

\* available as an optional extra

\*\* requires programming prior to dispatch

### Wiring Guide

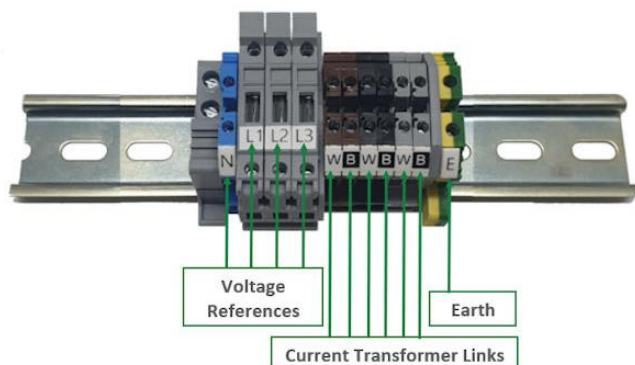

### Current Transformer Options

Part Code *	Ratio	Aperture
3CT100T24	100/5	24mm
3CT100T36	100/5	36mm
3CT150T24	150/5	24mm
3CT150T36	150/5	36mm
3CT200T24	200/5	24mm
3CT200T36	200/5	36mm
3CT250T24	250/5	24mm
3CT250T36	250/5	36mm
3CT300T24	300/5	24mm
3CT300T36	300/5	36mm
3CT400T36	400/5	36mm

\* Set of 3 Split Core CT's

**Web: [www.spwales.com](http://www.spwales.com) | Email: [sales@spwales.com](mailto:sales@spwales.com) | Phone: 01803 295430 | Fax: 01803 212819**

While Stephen P Wales Ltd has made every reasonable effort to ensure the accuracy of this information, Stephen P Wales Ltd does not guarantee that it is error-free, nor does Stephen P Wales Ltd make any other representation, warranty or guarantee that the information is accurate, correct, reliable or current. Stephen P Wales Ltd reserves the right to make any adjustments to the information contained herein at any time without notice.