

Acrel

ADL400 – User Manual

GENERAL

This CT operated DIN Rail meter is for use with three phase supplies and measures electrical parameters including Current (I), Voltage (V), Power (kW/kVA/kVAR), Power Factor (PF), Frequency (Hz), Imported, Exported and Total Energy (kWh/kVARh).

It's MID approved, allowing it to be used for billing applications and is highly accurate, (Class C, $\pm 0.5\%$). With both a Pulse Output and RS485 Modbus RTU it can be integrated with BMS or remote monitoring systems.

SPECIFICATION

Meter Type	Three Phase (3P4W / 3P3W)
Fitting Type	DIN Rail
Max. Current (Amps)	6 A
MID Approved	Yes
Smart	No
Input Type	Current Transformer
Tariffs	Single
Import / Export	Import & Export
Module Width	4
Reference voltage	3 x 230/400V
Consumption	<10VA (Single phase)
Impedance	>2M Ω
Power	Active, Reactive, Apparent Power, error $\pm 0.5\%$
Frequency	45 - 65Hz, Error $\pm 0.2\%$
Energy Accuracy	Active energy (Class: 0.5) Reactive energy (Class 2)
Clock	≤ 0.5 s/d
Energy pulse output	1 active photocoupler output
Width of pulse	80 \pm 20ms
Pulse constant	400imp/kWh, 10000imp/kWh calculated at base current
Interface and communication protocol	RS485 : Modbus RTU
Range of communication address	Modbus RTU: 1 - 254









Baud rate	1200bps - 19200bps
Working temperature	-25°C - +55°C
Relative humidity	$\leq 95\%$ (No condensation)
IP Rating	IP20
LCD Display	12 bits section LCD display, background 12 digit LCD backlit display
Key programming	3 keys to communication and set parameters

MEASURED PARAMETERS

- Active Energy (kWh)
- Active Power (W)
- Apparent Energy (kVAh)
- Apparent Power (VA)
- Current (I)
- Frequency (Hz)
- Line to Line Voltage (V)
- Power Factor (PF)
- Reactive Energy (kVARh)
- Reactive Power (VAR)
- Total Harmonic Distortion (Amps)
- Total Harmonic Distortion (Volts)
- Voltage (V)

SETUP

The following instruction directs how to set the CT ratio on this meter. This **MUST** be done before use to ensure accurate readings. All other settings can be adjusted using the same method.

- Press and hold the  to enter the setup menu. Enter the password, (default is "0001"), using the  button to move the cursor and the  button to change the value, then press .
- Use the  or  buttons to scroll through the values until it says "Ct" on the top line. Press  and the last value will start to flash.
- Using the  button to move the cursor and the  button to change the value, set this to the CT rate required, (e.g. if using a 200/5 CT, this value would

be set at 40, i.e. $200 \div 5$), then press  and the values will stop flashing.

4. Once complete, press and hold the  button and select Yes to save or No to exit without saving changes.

List of Available Settings

Symbol	Description	Range
Addr	Modbus Address	1 - 254
bAud	Baud rate	1200, 2400, 4800, 9600, 19200
Pari	Parity	None, Odd, Even
Hi	High	645 Comms protocol (N/A)
Lo	Low	
Led	Backlight time	0-255 minutes, more than 250 lights stay on
PL	Wiring sample	3P4L: 3 phase 3 wires 3P3L: 3 phase 4 wires
Dir	Direction of current	no-Forward, yes-Reverse
S-ty	App. Power Calc.	P Q or U I (N/A)
EF-E	Tariff Set	N/A on this model
Pt	Voltage transformer settings (primary)	1 - 9999
Ct	Current transformer settings (primary)	1 - 9999
COdE	Code settings	1 - 9999
PHAS	Phase Angle Calc.	$U_a/U_b/U_c$ to I_a , U_a to I_a , U_b to I_b , U_c to I_c
nOst	Starting power Freq.	0.1 – 2.0

WIRING & INSTALLATION

The ADL400 is designed to be installed on a 35mm DIN Rail

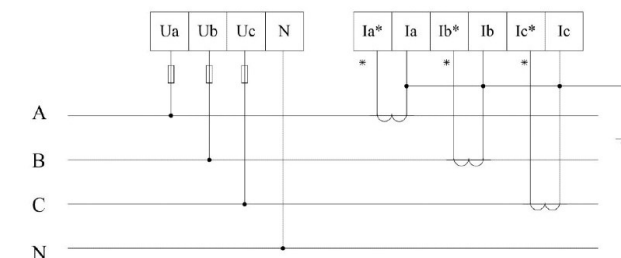

Three phase four wire

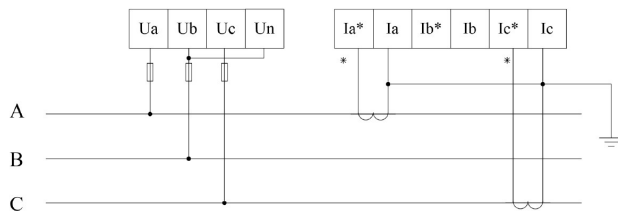

Three phase three wire

* Voltage references require a 100mA fuse

(Torque setting should not be greater than 1.5-2Nm)

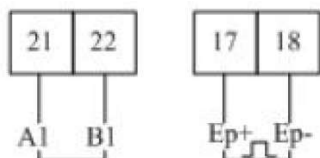

RS485 active energy pulse

Wiring diagram of communication and pulse terminals

DIMENSIONS

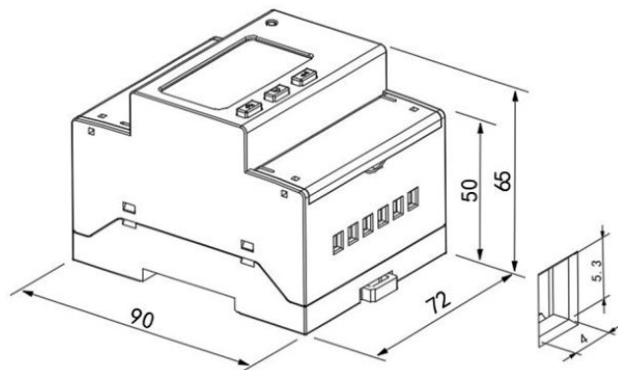

HOW TO USE

This unit features 3 buttons used to display the measured electrical parameters:



Voltage & Current



Power

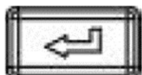

Energy

Voltage & Current

Using the button displays the following parameters:



Voltage (V)



Line to Line Voltage (V)

Current (A)

Frequency (Hz)



Total Harmonic Distortion (V)



Total Harmonic Distortion (A)



Phase Angle



Check bit, baud rate, table add.

645 Comms protocol (N/A)

Software Version & Unique Meter ID

Software Verification Code

Error Indication (0 = normal)

Full Display

Power

Using the button displays the following parameters:

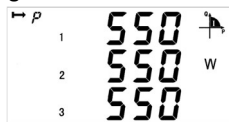

Active Power per Phase (W)

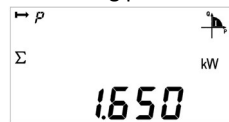

Total Active Power (kW)



Reactive Power per Phase (VAR)

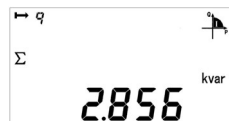

Total Reactive Power (kVar)



Apparent Power per Phase (kVa)

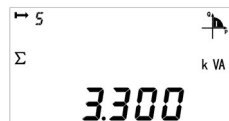

Total Apparent Power (kVa)



Power Factor per Phase



Total Power Factor

Energy

Using the button displays the following parameters:



Total Active Energy (kWh)

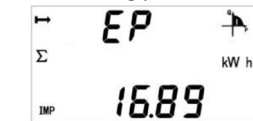

Imported Active Energy (kWh)



Exported Active Energy (kWh)



Total Reactive Energy (kVarh)

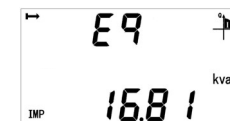

Imported Reactive Energy (kVarh)



Exported Reactive Energy (kVarh)

Imported Active Energy (kWh) - Phase 1

Imported Active Energy (kWh) - Phase 2

Imported Active Energy (kWh) - Phase 3

MODBUS PROTOCOL

For the full Modbus Protocol please visit:

<http://downloads.spwales.com/tpdac400-protocol.pdf>

Or use the following QR code:

