

DIRIS A20

1 Output

Notice d'utilisation

Operating instructions - Bedienungsanleitung
Istruzioni per l'uso - Gebruiksaanwijzing
Instrucciones de servicio - Manual de instruções

F

GB

D

I

NL

E

P

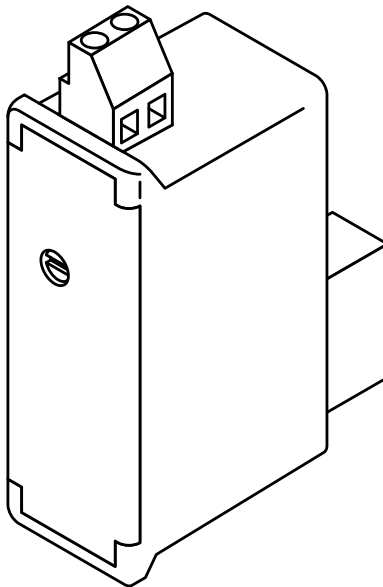

F

Sommaire

OPÉRATIONS PRÉALABLES	4
PRÉSENTATION.....	5
INSTALLATION.....	6
PROGRAMMATION.....	7
CARACTÉRISTIQUES TECHNIQUES.....	16
LEXIQUE DES ABRÉVIATIONS.....	18

GB

Contents

PRELIMINARY OPERATIONS	4
PRESENTATION.....	5
INSTALLATION.....	6
PROGRAMMING.....	7
TECHNICAL CHARACTERISTICS.....	16
GLOSSARY OF ABBREVIATION.....	18

D

Inhaltsverzeichnis

VORUSGEHENDE KONTROLLEN	4
PRODUKTDARSTELLUNG.....	5
INSTALLATION.....	6
KONFIGURATION	7
TECHNISCHE DATEN.....	16
GLOSSAR DER ABKÜRZUNGEN	18

I

Sommario

OPERAZIONI PRELIMINARI.....	4
PRESENTAZIONE	5
INSTALLAZIONE	6
PROGRAMMAZIONE	7
CARATTERISTICHE TECNICHE	16
ELENCO DELLE ABBREVIAZIONI	18

NL

Inhoud

VOORAFGAANDE HANDELINGEN	4
PRESENTATIE	5
INSTALLERING	6
PROGRAMMERING	7
TECHNISCHE EIGENSCHAPPEN.....	17
LIJST VAN AFKORTINGEN	18

E

Índice

OPERACIONES PREVIAS	4
PRESENTACIÓN	5
INSTALACIÓN	6
PROGRAMACIÓN	7
CARACTERÍSTICAS TÉCNICAS	17
LÉXICO DE LAS ABREVIACIONES.....	18

P

Índice

OPERAÇÕES PRELIMINARES.....	4
APRESENTAÇÃO	5
INSTALAÇÃO	6
PROGRAMAÇÃO	7
CARACTERÍSTICAS TÉCNICAS	17
LÉXICO DAS ABREVIATURSA.....	18

DIRIS A20 - 1 Output

OPÉRATIONS PRÉALABLES

PRELIMINARY OPERATIONS - VORAUSGEHENDE KONTROLLEN -

OPERAZIONI PRELIMINARI - VOORAGAANDE HANDELINGEN -

OPERACIONES PREVIAS - OPERAÇÕES PRELIMINARES

F

Au moment de la réception du colis contenant le module option, il est nécessaire de vérifier les points suivants :

- l'état de l'emballage,
- le produit n'a pas eu de dommage pendant le transport,
- la référence de l'appareil est conforme à votre commande,
- l'emballage comprend le produit,
- une notice d'utilisation.

NL

Bij ontvangst van de doos met de optie-module moeten de volgende punten gecontroleerd worden:

- de staat van de verpakking;
- of het product geen schade heeft geleden tijdens het transport;
- of de referentie van het toestel overeenkomt met de bestelling;
- de verpakking bevat een product;
- of de gebruiksaanwijzing aanwezig is.

GB

Check the following points as soon as you receive the optional module package:

- the packing is in good condition,
- the product has not been damaged during transit,
- the product reference number conforms to your order,
- the package contains the product,
- the operating instructions.

E

Al recibir el paquete que contiene el módulo opcional, será necesario verificar los aspectos siguientes:

- estado del embalaje;
- que el producto no se haya dañado durante el transporte;
- que la referencia del Aparato esté conforme con su pedido;
- el embalaje incluye el producto;
- el manual de utilización.

D

Bei Empfang des Gerätes Optionsmodul muß folgendes überprüft werden:

- Zustand der Verpackung,
- Sind Transportschäden zu melden,
- Entspricht der Packungsinhalt Ihrer Bestellung,
- Die Verpackung enthält das Produkt,
- Eine Bedienungsanleitung ist beigelegt.

P

Na altura da recepção da encomenda do módulo opção, é necessário verificar os seguintes pontos:

- o estado da embalagem;
- se o produto não foi danificado durante o transporte;
- se a referência do Aparelho está acordo com a sua encomenda;
- dentro da embalagem encontrase realmente o produto;
- se existe um manual de utilização.

I

Al momento del ricevimento della scatola contenente il modulo opzione, è necessario verificare i seguenti punti:

- lo stato dell'imballo;
- la presenza di danneggiamenti o rotture dovuti al trasporto;
- se il numero di riferimento dell'apparecchio è conforme a quello della richiesta;
- l'imballaggio comprende il prodotto;
- la presenza del libretto di istruzione originale.

DIRIS A20 - 1 Output

PRÉSENTATION

PRESENTATION - INSTALLATION - PRESENTAZIONE -
PRESENTATIE - PRESENTACIÓN - APRESENTAÇÃO

F Ce module option doit être connecté aux **DIRIS A20** (réf. 48250200, 4825U200) ou au **COUNTIS E53** (réf. 48503011). Ce module permet d'associer la sortie à un fonctionnement en sortie impulsionnelle, en alarme (sur toutes les grandeurs électriques) ou en commande (via la communication RS485).

NL Deze optiemodule moet worden aangesloten op de **DIRIS A20** (réf. 48250200, 4825U200) of de **COUNTIS E53** (réf. 48503011). Met deze module kan de uitgang worden gekoppeld aan een werking als impulsionele uitgang, als alarm (op alle elektrische grootheden) of als commando (via de RS 485-communicatie).

GB This optional module must be connected to the **DIRIS A20** (réf. 48250200, 4825U200) or to the **COUNTIS E53** (réf. 48503011). This module allows the output to be linked to a pulse output mode, alarm mode (for all electrical values) or control mode (via RS 485 communication).

E Este módulo opcional se debe conectar a los modelos **DIRIS A20** (réf. 48250200, 4825U200) o a los **COUNTIS E53** (réf. 48503011). Este módulo permite asociar la salida a un funcionamiento con salida de impulsos, con alarma (en todas las magnitudes eléctricas) o con control (a través de la comunicación RS 485).

D Dieses Optionsmodul muss an **DIRIS A20** (réf. 48250200, 4825U200) oder an **COUNTIS E53** (réf. 48503011) angeschlossen sein. Dieses Modul ermöglicht die Konfiguration des Ausgangs als Impuls- oder Alarmausgang (bei allen elektrischen Größen) sowie als Steuerung (über die Kommunikationsschnittstelle RS 485).

P Este módulo opção deve ser ligado aos **DIRIS A20** (réf. 48250200, 4825U200) ou aos **COUNTIS E53** (réf. 48503011). Este módulo permite associar a saída a um funcionamento em saída impulsional, em alarme (em todas as grandezas eléctricas) ou em comando (através da comunicação RS 485).

I Questo modulo opzione deve essere collegato ai **DIRIS A20** (réf. 48250200, 4825U200) o ai **COUNTIS E53** (réf. 48503011). Questo modulo consente di associare l'uscita ad un funzionamento come uscita a impulsi, come allarme (su tutti i valori elettrici) o come comando (mediante comunicazione RS 485).

DIRIS A20 - 1 Output

INSTALLATION

INSTALLATION - INSTALLATION - INSTALLAZIONE -
INSTALLERING - INSTALACIÓN - INSTALAÇÃO

RACCORDEMENT

- GB** Connection
- D** Anschluß
- I** Collegamento
- NL** Aansluiting
- E** Parte trasera
- P** Ligação



Le DIRIS A20 doit être hors tension.

This DIRIS A20 must be switched off.

Der DIRIS A20 darf nicht unter Spannung stehen.

Il DIRIS A20 deve essere fuori tensione.

De DIRIS A20 moet zonder spanning staan.

El DIRIS A20 deberá estar desconectado.

O DIRIS A20 deve ficar desligado.

1

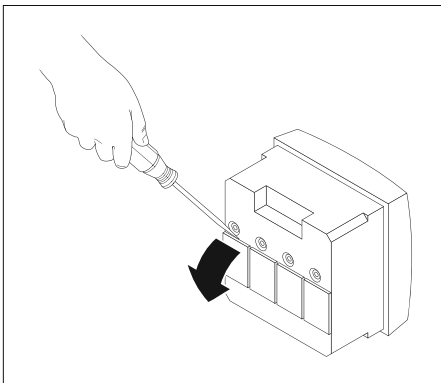

2

Fixer le module - Fix the module - Befestigen Sie das Modul - Fissare il modulo - Bevestig de module - Fije el módulo - Fixe o módulo

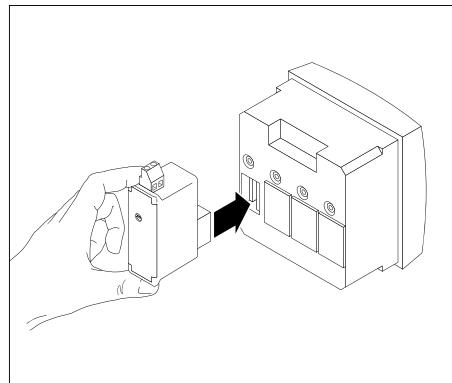

3

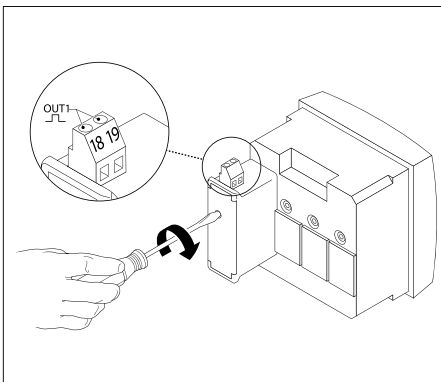

4

Raccorder le bornier en respectant les indications. Remettre sous tension.

Follow indications when connecting the terminal. Switch on voltage supply.

Für den Anschluß der Klemmleiste beachten Sie die entsprechenden Hinweise. Wieder einschalten.

Raccordare i morsetti rispettando le indicazioni. Alimentare il DIRIS A20.

De klemmenstrook aansluiten zoals aangegeven. Terug spanning geven.

Conexionar respetando las indicaciones. Poner en tensión

Ligar o terminal de bornes respeitando as indicações. Colocar sob tensão novamente.

DIRIS A20 - 1 Output

PROGRAMMATION

PROGRAMMING - KONFIGURATION - PROGRAMMAZIONE -
PROGRAMMERING - PROGRAMACIÓN - PROGRAMAÇÃO

TYPE DE LA SORTIE

- GB** Output type
- D** Ausgangstyp
- I** Tipo di uscita
- NL** Type van de uitgang
- E** Tipo de salida
- P** Tipo da saída



AFFECTATION DE LA GRANDEUR A SURVEILLER - Exemple : Type I

- | | |
|--|--|
| <ul style="list-style-type: none"> GB Allocation of the value to be monitored
Example: Type I D Zuweisung der zu überwachenden Größe
Beispiel: Type I I Assegnazione del valore da controllare
Esempio: Type I | <ul style="list-style-type: none"> NL Toewijzing van de te bewaken grootheid
Voorbeeld: Type I E Asignación de la magnitud que se debe supervisa
Ejemplo: Type I P Afectação da grandeza a controlar
Exemplo: Type I |
|--|--|

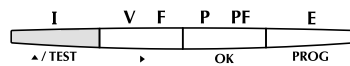
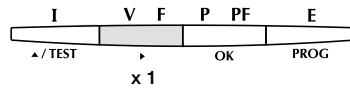

- x 1 = I
- x 2 = In
- x 3 = UP
- x 4 = UP
- x 5 = P
- x 6 = Q
- x 7 = S
- x 8 = CPF
- x 10 = LPF
- x 11 = thd I
- x 12 = thd U
- x 13 = thd V
- x 14 = Hour

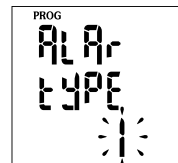
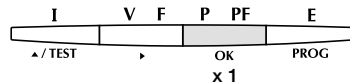

DIRIS A20 - 1 Output

PROGRAMMATION

PROGRAMMING - KONFIGURATION - PROGRAMMAZIONE -
PROGRAMMERING- PROGRAMACIÓN - PROGRAMAÇÃO

SEUIL HAUT DE LA SORTIE - Exemple : Ht = 200A

- GB** Output upper threshold
Example: Ht = 200
- D** Oberer Schwellenwert des Ausgangs
Beispiel: Ht = 200
- I** Soglia alta dell'uscita
Esempio: Ht = 200
- NL** Hoge uitgangsdrempel
Voorbeeld: Ht = 200
- E** Umbral alto de salida
Ejemplo: Ht = 200
- P** Limiar superior da saída
Exemplo: Ht = 200

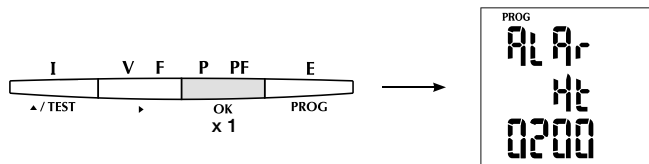
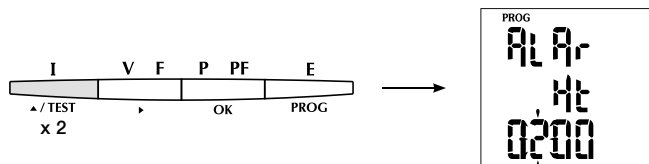
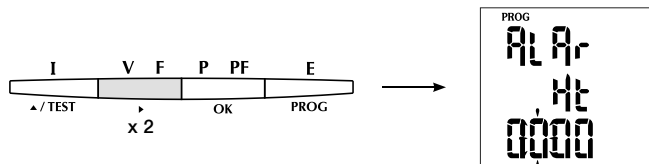

SEUIL BAS DE LA SORTIE - Exemple : Lt = 100A

- GB** Output lower threshold
Example: Lt = 100
- D** Unterer Schwellenwert des Ausgangs
Beispiel: Lt = 100
- I** Soglia bassa dell'uscita
Esempio: Lt = 100
- NL** Lage uitgangsdrempel
Voorbeeld: Lt = 100
- E** Umbral bajo de salida
Ejemplo: Lt = 100
- P** Limiar inferior da saída
Exemplo: Lt = 100

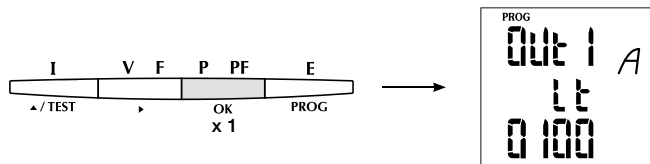
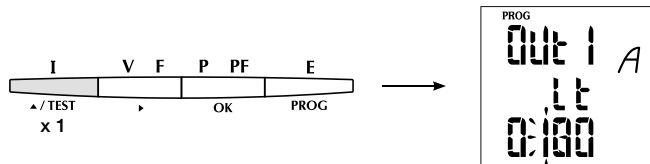
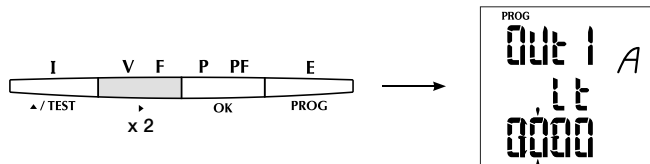

DIRIS A20 - 1 Output

PROGRAMMATION

PROGRAMMING - KONFIGURATION - PROGRAMMAZIONE -
PROGRAMMIERING- PROGRAMACIÓN - PROGRAMAÇÃO

HYSTERESIS DE LA SORTIE - Exemple : Hyst = 20%

- GB** Hysteresis threshold
Example: Hyst = 20%
- D** Hysterese des Ausgangs
Beispiel: Hyst = 20%
- I** Isteresi dell'uscita
Esempio: Hyst = 20%
- NL** Uigangshysterisis
Voorbeeld: Hyst = 20%
- E** Histéresis de salida
Ejemplo: Hyst = 20%
- P** Histerese da saída
Exemplo: Hyst = 20%

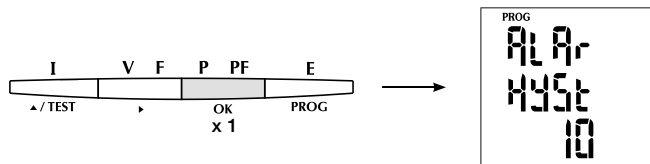
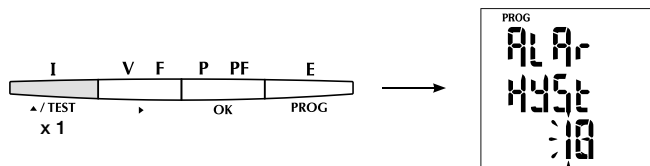
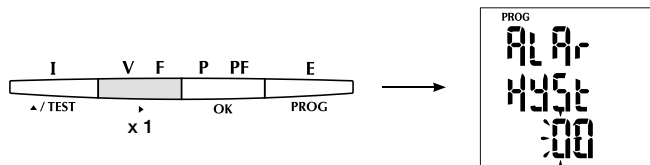

TEMPORISATION DE LA SORTIE - Exemple : Tempo = 30s

- GB** Time delay threshold
Example: Tempo = 30s
- D** Zeitverzögerung des Ausgangs
Beispiel: Tempo = 30s
- I** Temporizzazione dell'uscita
Esempio: Tempo = 30s
- NL** Uigangsvertraging
Voorbeeld: Tempo = 30s
- E** Temporización de salida
Ejemplo: Tempo = 30s
- P** Temporização da saída
Exemplo: Tempo = 30s

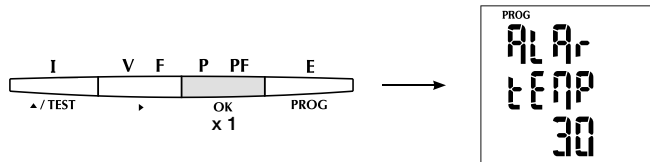
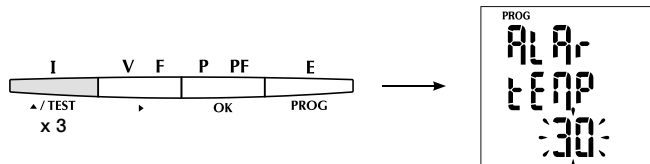
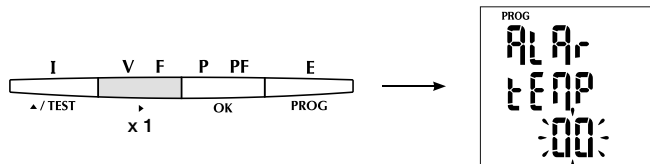

DIRIS A20 - 1 Output

PROGRAMMATION

PROGRAMMING - KONFIGURATION - PROGRAMMAZIONE -
PROGRAMMERING- PROGRAMACIÓN - PROGRAMAÇÃO

MODE DE TRAVAIL - Exemple : Relay = NC

- GB** Operating mode
Example: Relay = NC
- D** Arbeitsmodus
Beispiel: Relay = NC
- I** Modalità di lavoro
Esempio: Relay = NC
- NL** Werkmode
Voorbeeld: Relay = NC
- E** Modo de trabajo
Ejemplo: Relay = NC
- P** Modo de funcionamento
Exemplo: Relay = NC

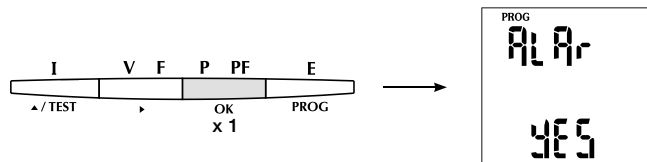
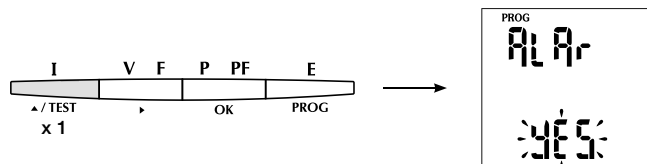
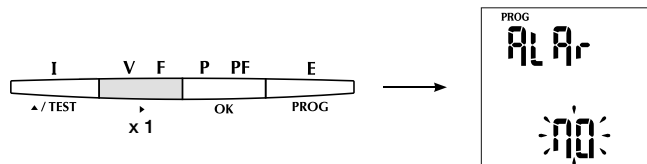

TYPE DE LA SORTIE - Exemple : tyPE = Er (kvarh)

- GB** Output type
Example: tyPE = Er (kvarh)
- D** Ausgangstyp
Beispiel: tyPE = Er (kvarh)
- I** Tipo di uscita
Esempio: tyPE = Er (kvarh)
- NL** Type van de uitgang
Voorbeeld: tyPE = Er (kvarh)
- E** Tipo de salida
Ejemplo: tyPE = Er (kvarh)
- P** Tipo da saída
Exemplo: tyPE = Er (kvarh)

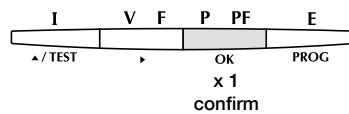
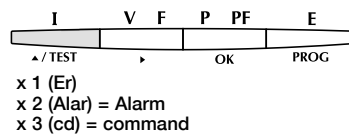
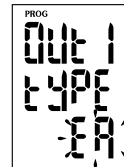
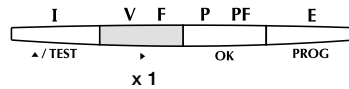

DIRIS A20 - 1 Output

PROGRAMMATION

PROGRAMMING - KONFIGURATION - PROGRAMMAZIONE -
PROGRAMMERING- PROGRAMACIÓN - PROGRAMAÇÃO

POIDS DE LA SORTIE IMPULSIONS - Exemple : VAL = 100 (1- μ = 100 kvarh)

GB Pulse output rate
Example: VAL = 100 (1- μ = 100 kvarh)

D Ausgangsimpulswertigkeit
Beispiel: VAL = 100 (1- μ = 100 kvarh)

I Peso degli uscita impulsi
Esempio: VAL = 100 (1- μ = 100 kvarh)

NL Gewicht van pulsuitegang
Voorbeeld: VAL = 100 (1- μ = 100 kvarh)

E Peso de la salida de impulsiones
Ejemplo: VAL = 100 (1- μ = 100 kvarh)

P Peso de saída de impulsões
Exemplo: VAL = 100 (1- μ = 100 kvarh)

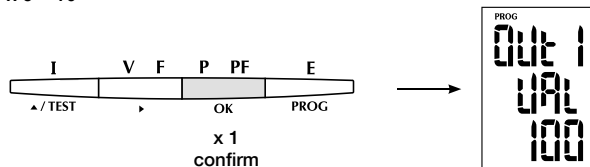
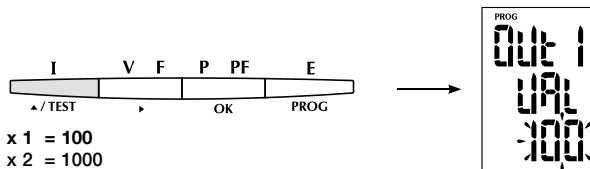
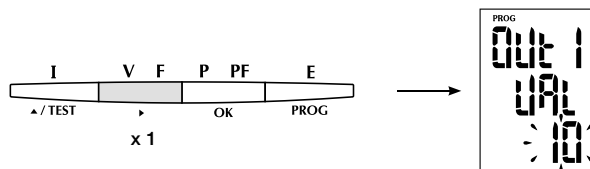

DURÉE DE LA SORTIE IMPULSIONS - Exemple : dUr = 300 ms

- GB** Pulse output durations
Example: dUr = 300 ms
- D** Dauer des Impulsausgangs
Beispiel: dUr = 300 ms
- I** Durata dell' uscita ad impulsi
Esempio: dUr = 300 ms
- NL** Duur van de pulsenuitgang
Voorbeeld: dUr = 300 ms
- E** Duración de la salida de impulsiones
Ejemplo: dUr = 300 m
- P** Duração da saída de impulsões
Exemplo: dUr = 300 ms

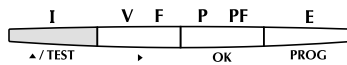
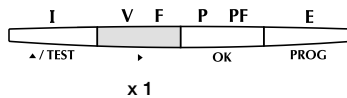

- x 1 = 200 ms
- x 2 = 300 ms
- x 3 = 400 ms
- x 4 = 500 ms
- x 5 = 600 ms
- x 6 = 700 ms
- x 7 = 800 ms
- x 8 = 900 ms
- x 9 = 60 ms
- x 10 = 100 ms

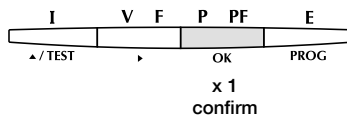

DIRIS A20 - 1 Output

CARACTÉRISTIQUES TECHNIQUES

TECHNICAL CHARACTERISTICS - TECHNISCHE DATEN -
CARATTERISTICHE TECNICHE - TECHNISCHE EIGENSCHAPPEN -
CARACTERÍSTICAS TÉCNICAS - CARACTERÍSTICAS TÉCNICAS

Relais reed	max. 100 V DC - 0,5 A - 10 VA
Nombre de manœuvres	≤ 10 ⁸
Isolation galvanique (tension d'isolement AC)	2,5 kV
UL - CSA Approval	
Normes	UL 61010-1 CSA-C22.2 No. 61010-1
Certificat	N° de dossier UL : E257746

Reed relays	max. 100 V DC - 0,5 A - 10 VA
N° of operations	≤ 10 ⁸
Galvanic insulation (AC insulation voltage)	2,5 kV
UL - CSA Approval	
Standard	UL 61010-1 CSA-C22.2 No. 61010-1
Certificate	UL file No: E257746

Reed-relais	max. 100 V DC - 0,5 A - 10 VA
Anzahl der Schaltspiele	≤ 10 ⁸
Galvanische trennung (Isolationsspannung AC)	2,5 kV
UL - CSA Approval	
Standard	UL 61010-1 CSA-C22.2 No. 61010-1
Certificate	UL file No: E257746

Relais reed	max. 100 V DC - 0,5 A - 10 VA
Numero di operazioni	≤ 10 ⁸
Isolamento galvanico (tensione di isolamento AC)	2,5 kV
UL - CSA Approval	
Standard	UL 61010-1 CSA-C22.2 No. 61010-1
Certificate	UL file No: E257746

DIRIS A20 - 1 OUTPUT

CARACTERISTIQUES TECHNIQUES

Relais reed	max. 100 V DC - 0,5 A - 10 VA
Aantal handelingen	$\leq 10^8$
Galvanische isolatie (AC isolatiespanning)	2,5 kV
UL - CSA Approval	
Standard	UL 61010-1
	CSA-C22.2 No. 61010-1
Certificate	UL file No: E257746

Relé herméticamente sellado (reed)	max. 100 V DC - 0,5 A - 10 VA
Número de maniobras	$\leq 10^8$
Aislamiento galvánico (tensión de aislamiento AC)	2,5 kV
UL - CSA Approval	
Norma	UL 61010-1
	CSA-C22.2 No. 61010-1
Certificado	No de expediente UL: E257746

Relés reed	max. 100 V DC - 0,5 A - 10 VA
Número de maniobras	$\leq 10^8$
Isolamento galvánico (tensão de isolamento AC)	2,5 kV
UL - CSA Approval	
Standard	UL 61010-1
	CSA-C22.2 No. 61010-1
Certificate	UL file No: E257746

DIRIS A20 - 1 Output

LEXIQUE DES ABRÉVIATIONS

GLOSSARY OF ABBREVIATIONS - GLOSSAR DER ABKÜRZUNGEN -
ELENCO DELLE ABBREVIAZIONI - LIJST VAN AFKORTINGEN -
LÉXICO DE LAS ABBREVIACIONES - LÉXICO DAS ABBREVIATURAS

F

Out 1	Sortie impulsionnelle 1
TYPE	Affectation de la sortie impulsionnelle
EA+	Energie active positive (kWh+)
ER+	Energie réactive positive (kvarh+)
VAL	Poids de l'impulsion
DUR	Durée de l'impulsion

NL

Out 1	Impulsuitgang 1
TYPE	Impulsgewicht
EA+	Actieve positieve energie (kWh+)
ER+	Reactieve positieve energie (kvarh+)
VAL	Impulsgewicht
DUR	Impulsduur

GB

Out 1	Pulse output 1
TYPE	Pulse output allocation
EA+	Positive active power (kWh+)
ER+	Positive reactive power(kvarh+)
VAL	Pulse value
DUR	Pulse duration

E

Out 1	Salida de impulsos 1
TYPE	Asignación de la salida de impulsos
EA+	Energía activa positiva (kWh+)
ER+	Energía reactiva positiva (kvarh+)
VAL	Peso del impulso
DUR	Duración del impulso

D

Out 1	Impulsausgang 1
TYPE	Zuweisung des Impulsausgangs
EA+	Positive Wirkenergie (kWh+)
ER+	Positive Blindenergie (kvarh+)
VAL	Impulswertigkeit
DUR	Impulsdauer

P

Out 1	Saída por impulsos 1
TYPE	Atribuição da saída por impulsos
EA+	Energia activa positiva (kWh+)
ER+	Energia reactiva positiva (kvarh+)
VAL	Peso do impulso
DUR	Duração do impulso

I

Out 1	Uscita impuls 1
TYPE	Impostazione dell'uscita impuls
EA+	Energia attiva positiva (kWh+)
ER+	Energia reattiva positiva(kvarh+)
VAL	Peso dell'impulso
DUR	Durata dell'impulso

HEAD OFFICE

SOCOMEK GROUP

S.A. SOCOMEK capital 11 149 200 €
R.C.S. Strasbourg B 548 500 149
B.P. 60010 - 1, rue de Westhouse
F-67235 Benfeld Cedex - FRANCE

INTERNATIONAL SALES DEPARTMENT

SOCOMEK

1, rue de Westhouse - B.P. 60010
F - 67235 Benfeld Cedex - FRANCE
Tel. +33 (0)3 88 57 41 41 - Fax +33 (0)3 88 74 08 00
info.scp.isd@socomec.com

www.socomec.com

Non contractual document. © 2012, Socomec SA. All rights reserved.

