

# Installation and Operating Instructions

## Dual Load

Digital energy meter for two loads in an electrical system.

### Introduction

The Dual load solution combines multiple load measurement with plug and play CT in a single, digital product. This manual will provide all the necessary instructions to install and operate this instrument.

### Dual Load Configuration

This dual load meter is set up as standard in Dual Load configuration for convenience allowing independent access to two separate loads, identified as Power and Lighting. The following set-up guide provides instructions on how to navigate through the menu driven interface to make customisations

Dual Load – Mode 1

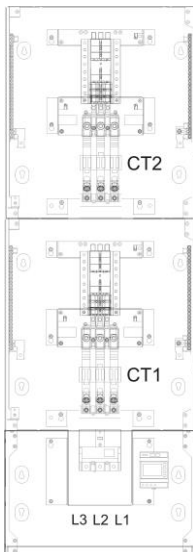
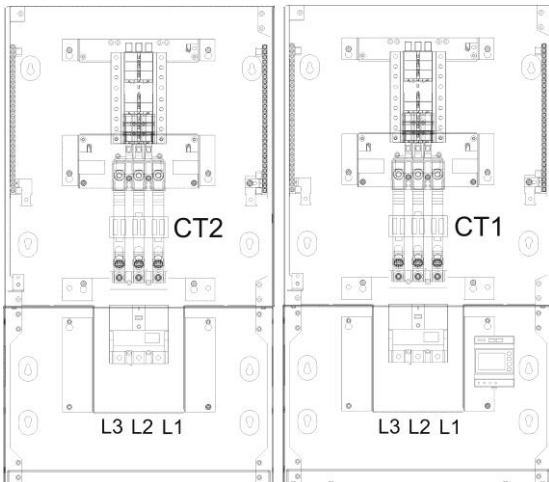





Dual Load - Mode 2











Fig. 1

### Measurement

In measurement mode, the buttons control the displayed measurement as follows:

	Pressing the top button labelled "POWER", LOAD1 (CT1) will display the Power circuit parameters V, I, kW, kWh.
	Pressing the second button down from the top labelled "LIGHT", LOAD2 (CT2) will display the Lighting circuit parameters V, I, kW, kWh
	Pressing the third button down will allow menu navigation during setup.
	Pressing the fourth bottom button labelled "SYSTEM" TOTAL LOAD, will the display System parameters V, I, kW, kWh, Hz, PF

### Setup

- Press and hold the two outermost buttons  and  simultaneously for five seconds until the password screen is displayed.
- Press  four times to enter the default password of "0000".
- The system setup screen will be displayed on the screen.
- Use the  and  buttons to set the digit to the required value then press  to confirm. The word "SET" will be displayed after the fourth digit has been entered to confirm that the value has been set.
- Press  to return to the first level menu structure. Use the  and  buttons to scroll up and down the menu structure to adjust another parameter. If no other settings are required, press  to exit set-up mode and return to measurement mode.

### Setup Menu Structure

#### Change password

nnnn - 4-digit number – default '0000'

#### Supply systems

3-phase 4-wire or Single phase (1-Phase 2-wire).

#### Display Mode

The meter has three modes,

**Mode 1** for two panel board applications See Fig.1

**Mode 2** for split load applications. See Fig 1

**SNGL** for single load applications (Power)

Follow the steps in **Mode Option Selection** to change the mode of operation.

**Reset** Resets cumulative energy measurements to zero

**Communication parameters** for RS485 interface

Modbus™ protocol

Baud rate 2400/4800/9600/19200/38400

Parity none/odd/even

Stop bits 1 (1 or 2 if parity is none)

RS485 network address nnn – 3-digit number 1 to 247

Order – Norm/Rev indicates if the Modbus™ word order is normal or reversed.

**Energy** Watts or KiloWatts.

**There is a selectable 1% Power Limit which, when invoked, prevents energy accumulation at powers below 1% of range maximum. This can prevent spurious kWh readings at low loads.**

#### Test











Display on – all elements on to check display

Display toggle - Each element is turned on and off

Phase sequence

**SOFT** Displays firmware version numbers











## Menu Option Selection

- After entering the correct password, use  and  buttons to navigate up and down the first level until the desired parameter is reached. Selection does not roll over from bottom to top of list or vice versa.
- Press the  button to select the desired parameter and enter the second level menu structure.
- If an item flashes then it can be adjusted by the  and  keys. If not, there may be a further layer, e.g. Comms - Baud rate, before adjustment is possible. Press  to select the lower layer.
- Having selected an option from the current menu layer, press  to confirm your selection. The SET indicator will appear.
- Once all the necessary selections have been made and the required settings entered, press  to return to the first level menu structure. The word SET will go off and one can then use the  and  keys for further menu selection.
- On completion of all setting-up, press  repeatedly until the measurement screen is restored.

## Mode Option Selection





There are three modes of operation for the Dual Load product. The default setting is Dual Load mode 1. In Dual Load mode 1 the total system is calculated from the sum of the two CT inputs. In Dual Load mode 2 the total system is measured by CT1 and the lighting circuit is measured by CT2 so the Power is calculated by the difference between the two inputs. In SNGL mode only the Power load is displayed.

	Operating Mode		
	Dual 1	Dual 2	SNGL
Power	Load 1 (CT1)	CT1-CT2	CT1
Lighting	Load 2 (CT2)	Load 2 (CT2)	
Total (System)	CT1 + CT2	Load 1 (CT1)	

- Press and hold the two outermost buttons  and  simultaneously for five seconds until the password screen is displayed.
- After entering the correct password, use  and  buttons to navigate until the mode menu is reached.
- Press the  button to select the mode menu
- Use  and  to select the required mode. (Dual1...)
- Having selected an option from the current menu layer, press  to confirm your selection. The SET indicator will appear.
- Once all the necessary selections have been made and the required settings entered, press  to return to the first level menu structure.
- On completion of all setting-up, press  repeatedly until the measurement screen is restored.

## Number Entry Procedure

When setting up the unit, some screens require the entry of a number. In particular, to enter the setting up section a password must be entered. Digits are set individually, from left to right. The procedure is as follows:

- The current digit to be set flashes and is set using the  and  keys.
- Press  to confirm each digit setting. The word SET will be displayed once the last digit has been set.
- After setting the last digit, press  to exit the number setting routine.

## Installation

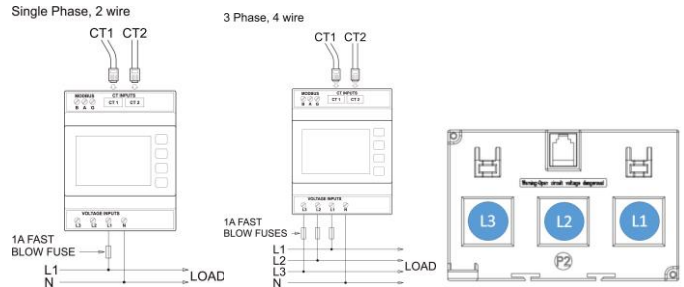

### WARNING.

**It is essential that the primary current is isolated BEFORE connecting or disconnecting the secondary current connections**

### Case Dimensions:

Width 71•3 mm, Depth 57•5 mm, Length 90•5 mm

Length including fixing tag 93•5 mm.

The unit is intended for mounting on a standard DIN rail. Avoid mounting the unit where there is excessive vibration; in excessive direct sunlight; or outside a reasonably stable ambient temperature of -10 to +55°C.

### Warnings



Caution: Risk of Electric Shock

- During normal operation, voltages hazardous to life may be present at some of the terminals of this unit.
- At voltages below that specified in the Range of Use the meter may shut down. However, voltages hazardous to life may still be present at some of the terminals of this unit.
- Installation and servicing should be performed only by qualified, properly trained personnel abiding by local regulations.
- Ensure all supplies are de-energised before attempting connection or other procedures.
- Terminals should not be user accessible after installation and external installation provisions must be sufficient to prevent hazards under fault conditions.
- This unit is not intended to function as part of a system providing the sole means of fault protection - good engineering practice dictates that any critical function be protected by at least two independent and diverse means.
- The unit does not have internal fuses therefore external fuses must be used for protection and safety under fault conditions.
- Never open-circuit the secondary winding of an energized current transformer.
- If this equipment is used in a manner not specified by the manufacturer, protection provided by the equipment may be impaired.

### Safety

The unit is designed in accordance with BS EN 61010-1:2001 (IEC 61010-1:2001) – Permanently connected use, Normal condition. Installation category III, pollution degree 2, basic insulation for rated voltage. Measurement Category III.

## EMC Installation Requirements

Whilst this unit complies with all relevant EU EMC (electromagnetic compatibility) regulations, any additional precautions necessary to provide proper operation of this and adjacent equipment will be installation dependent and so the following can only be general guidance:

- Avoid routing wiring to this unit alongside cables and products that are, or could be, a source of interference.
- The supply to the unit should not be subject to excessive interference. In some cases, a supply line filter may be required.
- To protect the product against incorrect operation or permanent damage, surge transients must be controlled. It is good EMC practice to suppress transients and surges at the source. The unit has been designed to automatically recover from typical transients; however in extreme circumstances it may be necessary to temporarily disconnect the supply for a period of greater than 10 seconds to restore correct operation.
- Screened communication leads are recommended and may be required. These and other connecting leads may require the fitting of RF suppression components, such as ferrite absorbers, line filters etc., if RF fields cause problems.
- It is good practice to install sensitive electronic instruments that are performing critical functions in EMC enclosures that protect against electrical interference causing a disturbance in function.

## Wiring

Connections are made via two-part connectors with screw clamp terminals and two RJ12 CT connections. Choice of cable should meet local regulations for the operating voltage. **The current inputs of this product are designed for connection into CTs supplied with the product only.**

Connector plugs are suitable for copper wires only and will accept one stranded 0.05 – 2.5mm<sup>2</sup> (30 - 12AWG) stranded or solid core cables. This instrument is intended for panel mounting. Terminals must be enclosed within the panel. For mains terminals use wire rated at 600V, 60°C minimum temperature. Terminal screws are fully tightened for shipment and must be undone before wire insertion. Terminal screws should be tightened to 0.5 Nm (4.4 lbf in) only.

## Fusing

This unit must be installed with external fuses in the voltage supply lines of type fast blow 1A maximum. Choose fuses of a type and with a breaking capacity appropriate to the supply and in accordance with local regulations.

A suitable switch or circuit breaker conforming to the relevant parts of IEC 60947-1 and IEC 60947-3 should be included in the installation. It should be positioned so as to be easy to operate, in close proximity to the equipment, and clearly identified as the disconnecting device.

## Maintenance

In normal use, little maintenance is needed. As appropriate for service conditions, isolate from electrical power, inspect the unit, and remove any dust or other foreign material present. Periodically check all connections for freedom from corrosion and screw tightness, particularly if vibration is present.

The front of the case should be wiped with a dry cloth only. Use minimal pressure, especially over the viewing window area. If necessary wipe the rear case with a dry cloth. If a cleaning agent is necessary, isopropyl alcohol is the only recommended agent and should be used sparingly. Water should not be used. If the rear case exterior or terminals should be contaminated accidentally with water, the unit must be thoroughly dried before further service. Should it be suspected that water might have entered the unit, factory inspection and refurbishment is recommended.

## Case Dimensions

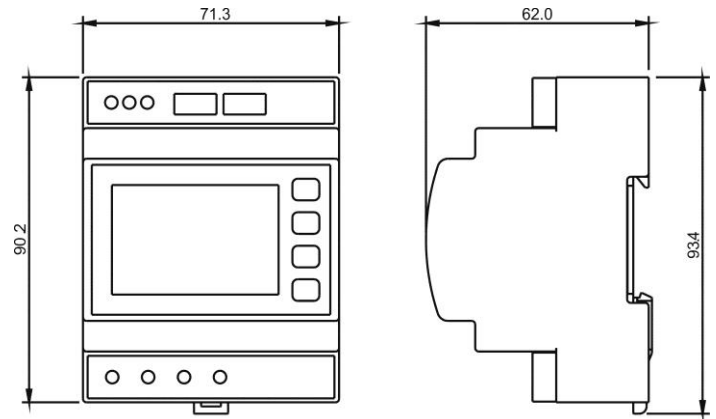

## Specification

### Measurement Inputs

Imported energies are recorded.

Six current inputs (Two physical terminals) with RJ12 connections for use with the supplied external CTs.

Voltage inputs and outputs through 4-way connectors with 2.5mm<sup>2</sup> stranded wire capacity. 3-Phase 4-wire unbalanced. Line frequency measured from L1 voltage or L3 voltage.

Direct measurement of 173 to 400V AC L-L (100 to 230Vac L-N)

### Range of Use

Values of measured quantities, components of measured quantities, and quantities which affect measurement errors to some degree, for which the product gives meaningful readings:

Voltage 31 ... 120% of Range Maximum  
Current 1 ... 120% of nominal

Active power 1 ... 144% of nominal

Apparent power 1 ... 144% of nominal

Power is only registered when voltage and current are within their respective range of use.

### Accuracy

Voltage (V) 0.5% of range maximum

Current (A) 0.5% of range maximum

Frequency (Hz) 0.2%

Power factor (PF) 1% of unity

Active power (W) ± 1% of range maximum

Active energy (kWh) Class 1 (IEC 62053-21) section 4.6<sup>1</sup>

Reactive energy (kVAh) Class 2 IEC 62053-23<sup>2</sup>

Response time to step input 1s typical to >99% of final value

**There is a selectable 1% Power Limit which, when invoked, prevents energy accumulation at powers below 1% of range maximum.**

**<sup>2</sup> Error in energy readings is expressed as a percentage of the energy count that would result from applying Range Maximum voltage and nominal current for the same measurement period.**

## RS485 output

Type	2-wire half duplex
Baud rate	2400, 4800, 9600, 19200, 38400

\*Ensure any external circuits connected to RS-485 output modules are provided with double/reinforced insulation.

### Reference Conditions of Influence Quantities

Influence Quantities are variables that affect measurement errors to a minor degree. Accuracy is verified under nominal value (within the specified tolerance) of these conditions.



Ambient temperature	23°C ±1°C
Input waveform	50 or 60Hz ±2%
Input waveform	Sinusoidal (distortion factor <0.005)
Magnetic field of external origin	Terrestrial flux

### Environment

Operating temperature	-10°C to +55°C*
Storage temperature	-20°C to +70°C*
*Maximum operating and storage temperatures are in the context of typical daily and seasonal variation.	
Relative humidity	0 to 90%, non-condensing
Altitude	Up to 2000m
Warm up time	1 minute
Vibration	10Hz to 50Hz, IEC 60068-2-6, 2g
Shock	30g in 3 planes
Dielectric voltage withstand test	2.2kV rms 50Hz for 1 minute between Measuring Voltage Inputs to RS485.

 Front Face Only

### Explanation of Symbols

-  Refer to manual
-  Danger of electric shock
-  Do not discard

Nominal input voltage	100 to 230V AC L-N
Max. continuous input overload voltage	120% of nominal
Max. short duration input voltage	2 x range maximum (1 second application repeated 5 times at 5 minute intervals)
Nominal input voltage burden	5VA nominal L1-N, < 0.2VA all other phases
Nominal input current	100mA, 0.1VA
Max. short duration input current	10 x nominal (1 second application repeated 5 times at 5 minute intervals)
Frequency	45 to 66Hz

### Compliance

EMC, Emissions	BS EN 61326, Class A (Industrial)
EMC, Immunity	BS EN 61326, Class A (Industrial)
Safety	BS EN 61010-1:2001

### Troubleshooting / FAQ

#### 1. Product Fails to power up

*The product is self powered. Check the voltage between L1 and N.*

#### 2. Incorrect kWh readings

*Check that that CT is the correct way round for the direction of the current flow.*

*Check the sequence of the phases through the CT*

*Check the sequence of Voltage connections L1, L2, L3.*

*Ensure that adequate load flows through the CT. The load must be more than 5% of the primary value.*

#### 3. Communications Failures

*If the product fails to communicate via the Modbus connector. Swap the A and B connections.*

While TE Connectivity (TE) has made every reasonable effort to ensure the accuracy of the information in this catalogue, TE does not guarantee that it is error-free, nor does TE make any other representation, warranty or guarantee that the information is accurate, correct, reliable or current. TE reserves the right to make any adjustments to the information contained herein at any time without notice. TE expressly disclaims all implied warranties regarding the information contained herein, including, but not limited to, any implied warranties of merchantability or fitness for a particular purpose. The dimensions in this catalogue are for reference purposes only and are subject to change without notice. Specifications are subject to change without notice. Consult TE for the latest dimensions and design specifications. TE Connectivity and TE connectivity (logo) are trademarks. CROMPTON is a trademark of Crompton Parkinson Limited and is used under licence. Other products or company names mentioned herein may be trademarks of their respective owners.



Tyco Electronics UK Ltd  
A TE Connectivity company  
Freebournes Road,  
Witham, CM8 3AH, UK  
Tel: +44 (0) 1376 509509  
Fax: +44 (0) 1376 509511  
www.crompton-instruments.com  
www.energy.te.com

Registered office:  
Faraday Road, Dorcan  
Swindon, SN3 5HH  
Reg. No. 550 926