

PowerRail300 Operating Guide

December 2007

1 Safety

This instruction sheet gives details of safe installation and operation of the **Rail300** electricity meter. Safety may be impaired if the instructions are not followed. Labels on each meter give details of equipment ratings for safe operation. Take time to examine all labels before commencing installation. Safety symbols on the meter have specific meanings.



Refer To User Manual



Risk of Electric Shock

WARNING

The meter contains no user serviceable parts. Installation and commissioning should only be carried out by qualified personnel

Further information is available at <http://www.ndmeter.co.uk>.

2 Operation

2.1 Energy Display

Press kWh

12345678 kWh

Energy Register

Scaling of the energy register is set by the nominal input currents and voltages and remains constant during operation of the meter.

If no keys are pressed, the meter will automatically revert to this page after 60 seconds. The energy register will accumulate from zero to 99,999,999 then restart from zero.

2.2 Power Display

Press kW

144.00 kW

Power Register

The instantaneous power display may show negative values indicating export power or incorrectly wired inputs.

2.3 Setup Display Menu

Each meter is configured to operate in a specific system. The meter settings may be displayed on the LCD in the **Setup Display Menu**.

Hold for 5 Seconds.

Ct 200 A

Current Transformer Primary

The **CT** value should match the **Nominal Primary** rating of the current transformers fitted with the meter.

Press

Un 400 V

Nominal Line-Line Voltage (or PT Primary)

If no external potential transformer (PT) is fitted **Un** is the **Rated Nominal Line-Line Voltage** as detailed on the meter label.

If a PT is fitted, its secondary voltage should match the Rated Nominal Line-Line Voltage of the meter, **Un** is then programmed as the **Nominal Rated Primary Voltage** of the PT.

Press

PLr 0.1 kWh

Output Pulse Rate

PLr indicates the amount of energy accumulated between each pulse output.

Press

PLt 0.1

Pulse On Time

PLt indicates the length of time (in seconds) the output pulse contacts remain short circuit for each pulse.

Press

OPt 1011

Options Fitted

OPt is a code indicating which factory fit options are supplied on an individual meter. This information may be requested when contacting technical support.

2.4 Pulse Output

An isolated pulse output is provided for connection to external systems such as Building Energy Management Systems (BEMS), data loggers, remote counters etc.

A single pulse occurs for each unit of energy on the display (eg 1 pulse per 0.1kWh). The pulse rate (amount of energy associated with each pulse) and pulse length may be set to suit the external system.

2.4.1 Pulse LED

A light emitting diode (LED) on the front panel of the instrument pulses ON during each output pulse.



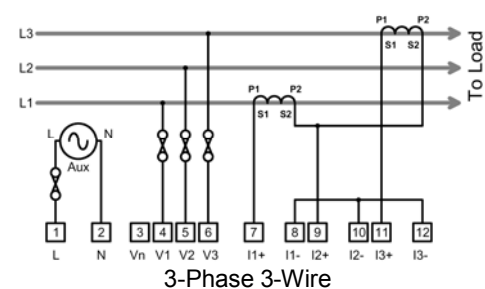
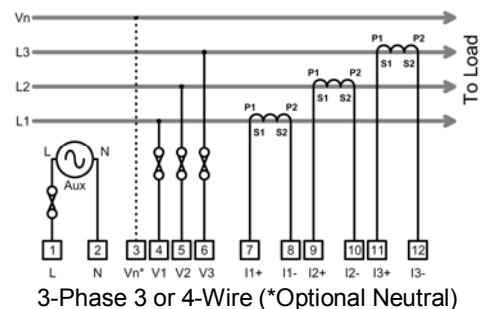

3 Standard Connections



4 Programming



4.1 Programming Menu

To enter programming mode:

Hold  and  together for 5 Seconds.
The first programmable parameter, CT Primary, is displayed.



To change a value (eg CT Primary):

Press  or  until the required value is set.

To Move to The Next Setting:

Press  until the next parameter is displayed.

Program Menu Pages



Current Transformer Primary



Nominal Line-Line V (or PT Primary)



Output Pulse Rate



Pulse On Time





Pulse Output Test

After the last parameter is set the new values are stored and the meter continues to measure kWh with the new settings.

4.2 Fine Adjust

CT Primary and Nominal Voltage settings are selected from a table of preferred values. This reduces the time to program these parameters to industry standard values.

Fine Adjust Mode allows values other than those provided by the default tables to be set. To enter/exit **Fine Adjust Mode**:



Hold  and  together for 2 Seconds while setting **CT** or **Un**.

Fine Adjust Mode is indicated by a decimal point immediately after the parameter type (ie. "CT." or "Un.")

4.3 Pulse Output Test

This feature allows the pulse output hardware and external system connections to be commissioned without a measured load. The LCD shows **Pto** (off) and **Ptr** (run) and the number of test pulses. The test pulse rate is set automatically dependant on the programmed pulse length (maximum 0.5Hz).

Press  to start/stop the test pulses.

Press  and  together to stop the test pulses and simultaneously reset the test counter.

5 Display Scaling

The units, Wh, kWh or MWh and the position of the decimal point for the energy/power displays are automatically set dependant on the **CT** and **Un** settings for the meter.

The nominal 3-phase input for the meter is defined as:

$$W_{nom} = 1.732 \times Un \times CT$$

The display pages are scaled as follows:

W_{nom}	kW Resolution	kWh Resolution
< 243 W	0.1W	0.001 kWh
< 2.43 kW	0.1W	0.001 kWh
< 24.3 kW	0.001 kW	0.01 kWh
< 243 kW	0.01 kW	0.1 kWh
< 2.43 MW	0.1 kW	1 kWh
< 24.3 MW	1 kW	0.01 MWh
< 243 MW	0.01 MW	0.1 MWh
> 243 MW	0.1 MW	1 MWh

6 Mounting On A Rail

The **Rail300** conforms to DIN 43880, 6 Modules wide. The unit is therefore compatible with a number of standard distribution systems with 45mm cut-outs. The meter should be mounted on a 35mm symmetrical ("top-hat") DIN rail of minimum length 106mm.

7 Pulse Output Connection

The pulse output takes the form of an isolated volt free normally open contact pair.

The contacts are isolated from all other circuits (2.5kV / 1 minute).

The pulse can be used as an input to a remote counter, pulse logger, building energy management system etc.

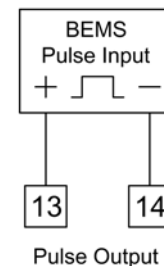

8 Specification

Aux Supply	Nominal 230Vac ±15%, 45-65Hz, 1W max. Optional 115Vac ±15%. Isolation 2.5kV (1 minute)
Input Voltage	Un 400V Line-Line. Range 20%-120% Un Burden 0.1VA / Phase. Overload 2xUn Continuous. Other nominal voltages are available to order.
Input Currents	Nominal Ib = 5A. Range 0.2%-120% Ib Burden 0.1VA / Phase. Overload 40xIb (1 sec) Isolation 2.5kV (1 minute) Optional Ib = 1A
Accuracy	KWh: Class 1. EN62053-21 & BS8431 (2% - 120% Nominal Load) KW: 1% Rdg (5% - 120% Nominal Load)
LCD Display	LCD 8 Digits h=6.7mm + Legends h=3.2mm. kWh Memory 10 years without power.
Pulse Output	Normally open volt free contacts 1 pulse per energy increment. Pulse rate and length selectable. Contacts: 100V ac/dc, 100mA, 5W max Isolation 2.5kV for 1 minute.
Environment	Operate-10°C > T < 65°C. RH < 75% Non Condensing Storage- 25C > T < 75C IP 54
Other	Size: 106 x 90 x 58mm (Cut out 106 x 45mm) DIN Rail: DIN EN 50022, 35mm. L=106mm (min) Case: DIN 43880, 6 Modules Wide Material: Noryl UL94V0 Self Extinguishing Terminals: Rising Cage 0.25mm ² to 4.0mm ² Weight: Approx 250g